

YBLXW-5/11(Z15G) Microswitch

1. General

YBLXW-5 series microswitches apply to the control circuit, whose alternating current is 50~60Hz, AC380V, Ie0.79A; DC220V, Ie0.14A. The switches are widely applied to the travel control, spacing protection and interlock of all kinds of machinery equipments, which are machinery, spinning, electronic instrument and so on. The normal operation of products are on altitude, which is not exceeding 2000m, environment temperature is -5°C~+40°C; humidity is 85%(20°C); operation frequency is 40 times every minute, level of protection is Ip52. Up to standard: GB 14048.5, IEC 60947-5-1, acquired CCC national compulsory product certification.

2. Type designation

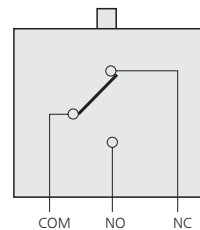
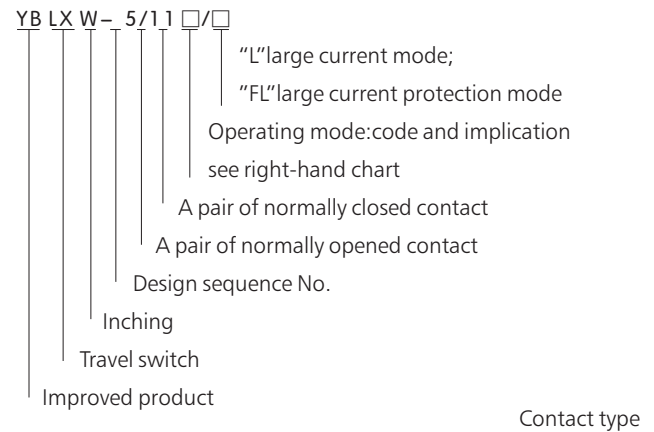

3. Technical data

Level of protection	IP52	
Mechanical life	100×10 ⁴ times	
Electrical life	30×10 ⁴ times	
Operation frequency	Machinery	240t/min
	Electric	20t/min
Load	Ordinary type	AC 380V 0.79A
		DC 220V 0.14A
	Large current mode	AC 660V 1.5A
		DC 220V 0.45A
Speed of operation	0.1mm/s~0.5mm/s	
Insulation resistance	≥1MΩ	
Contact resistance	≤100mΩ	
Environment temperature	-5°C~+40°C	
Relative humidity	≤90%(20°C)	
Altitude	≤2000m	
Withstand voltage	Between homopolar terminals(AC 1140V)	
	Between electrified metal pieces and ground(AC 1890V)	
	Between terminal and non-electrified metal pieces(2500V)	
Scope of application	The travel control, spacing protection, and interlock of all kinds of machinery equipments, which are machinery, spinning, electronic instrument and so on.	
Up to standard	GB 14048.5, IEC 60947-5-1	

Microswitch

Model	Operating mode
YBLXW-5/11Z	Handspike plunger type
YBLXW-5/11N2	Compression bar type
YBLXW-5/11G2	Roller compression bar type
YBLXW-5/11D	Short spring-loaded plunger type
YBLXW-5/11M	Panel mounting plunger type
YBLXW-5/11Q1	Panel mounting roller plunger type
YBLXW-5/11Q2	Panel mounting landscape roller plunger type
YBLXW-5/11N1	Hinge rail type
YBLXW-5/11G1	Hinge roller long rail type
YBLXW-5/11G2277	Hinge one-way roller long rail type
YBLXW-5/11G2	Hinge roller rail type

Voltage	Current						
	Heater load		Filament lamp load		Electromotor, relay solenoid coil load		
	Disconnect	Connect	Disconnect	Connect	Disconnect	Connect	
AC	127V	15A	15A	1.5A	3.0A	15A	15A
	220V	15A	15A	1.25A	2.5A	15A	15A
	380V	3A	3A	0.75A	1.0A	2.5A	2.5A
	660V	2A	2A	0.50A	0.8A	1.5A	1.5A
DC	24V	10A	10A	1.5A	3.0A	10A	10A
	110V	0.6A	0.6A	0.6A	0.6A	0.1A	0.1A
	220V	0.3A	0.3A	0.3A	0.3A	0.05A	0.05A

Model	YBLXW-5/11Z YBLXW-5/11Z/F YBLXW-5/11Z/L YBLXW-5/11Z/FL	YBLXW-5/11D YBLXW-5/11D/F YBLXW-5/11D/L YBLXW-5/11D/FL	YBLXW-5/11M YBLXW-5/11M/F YBLXW-5/11M/L YBLXW-5/11M/FL	YBLXW-5/11Q1 YBLXW-5/11Q1/F YBLXW-5/11Q1/L YBLXW-5/11Q1/FL	YBLXW-5/11Q2 YBLXW-5/11Q2/F YBLXW-5/11Q2/L YBLXW-5/11Q2/FL
Movement(OF)	≤8.5N	≤8.5N	≤8.5N	≤8.5N	≤8.5N
Maximum reset force	1N	1N	1N	1N	1N
Repeated accuracy error	±0.5mm	±0.5mm	±0.5mm	±0.5mm	±0.5mm
Movement route	≤2.5mm	≤2.5mm	≤2.5mm	≤2.5mm	≤2.5mm
Excess of stroke	≥0.6mm	≥0.6mm	≥3mm	≥3mm	≥3mm

Model	YBLXW-5/11N1 YBLXW-5/11N1/F YBLXW-5/11N1/L YBLXW-5/11N1/FL	YBLXW-5/11N2 YBLXW-5/11N2/F YBLXW-5/11N2/L YBLXW-5/11N2/FL	YBLXW-5/11G1 YBLXW-5/11G1/F YBLXW-5/11G1/L YBLXW-5/11G1/FL	YBLXW-5/11G2 YBLXW-5/11G2/F YBLXW-5/11G2/L YBLXW-5/11G2/FL	YBLXW-5/11G3 YBLXW-5/11G3/F YBLXW-5/11G3/L YBLXW-5/11G3/FL
Movement(OF)	≤4N	≤5N	≤4N	≤5N	≤4N
Maximum reset force	0.15N	0.25N	0.15N	0.25N	0.2N
Repeated accuracy error	±0.5mm	±0.5mm	±0.5mm	±0.5mm	±0.5mm
Movement route	≤12mm	≤9mm	≤10mm	≤6mm	≤7.5mm
Excess of stroke	≥3mm	≥2mm	≥3mm	≥2mm	≥2.5mm

4. Overall and mounting dimensions

YBLXW-5/11Z, YBLXW-5/11Z/L

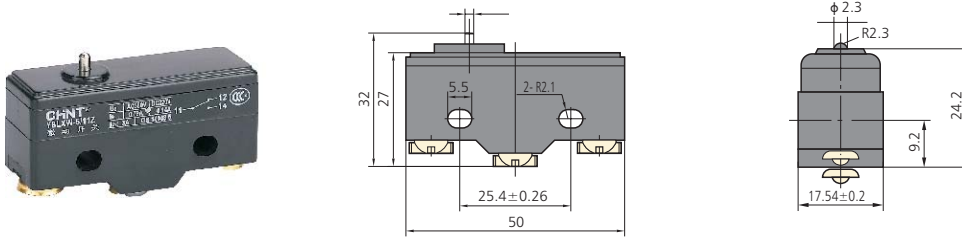

YBLXW-5/11N2, YBLXW-5/11N2/L

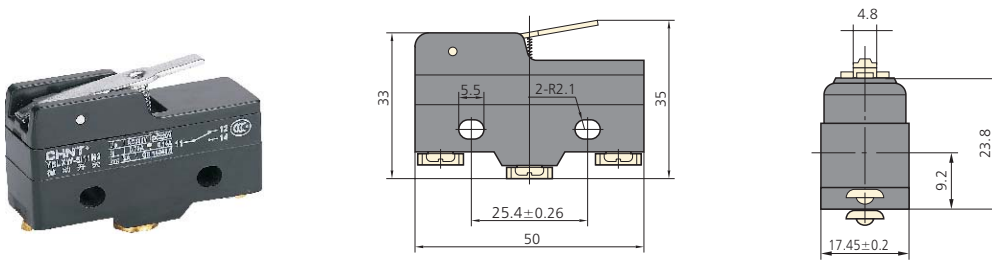

YBLXW-5/11G3, YBLXW-5/11G3/L

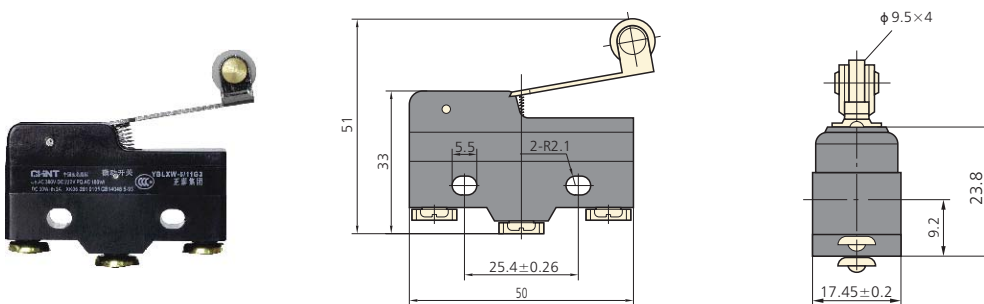

Microswitch

YBLXW-5/11D1, YBLXW-5/11D1/L

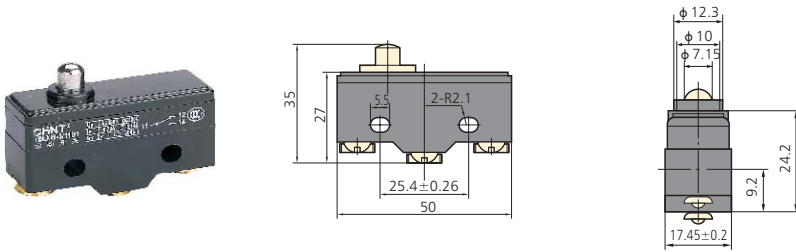

YBLXW-5/11M, YBLXW-5/11M/L

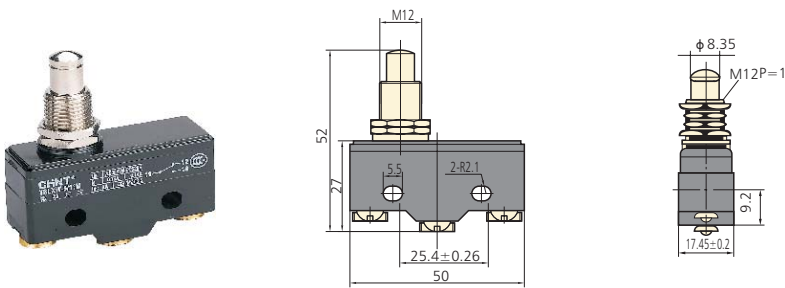

YBLXW-5/11Q1, YBLXW-5/11Q1/L

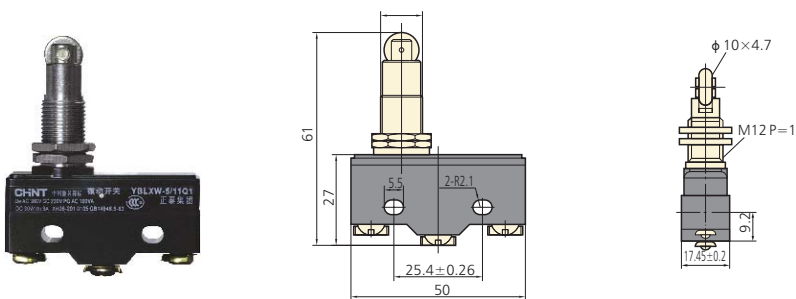

YBLXW-5/11Q2, YBLXW-5/11Q2/L

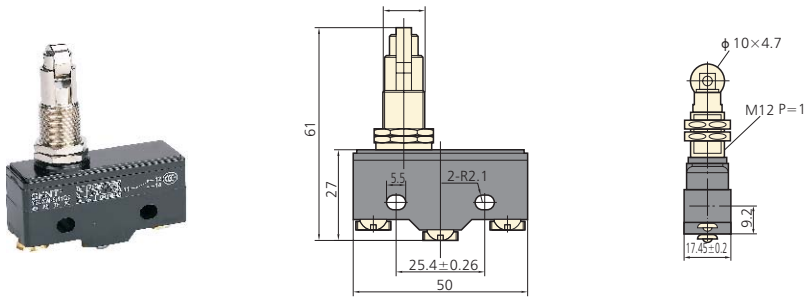

YBLXW-5/11N1, YBLXW-5/11N1/L

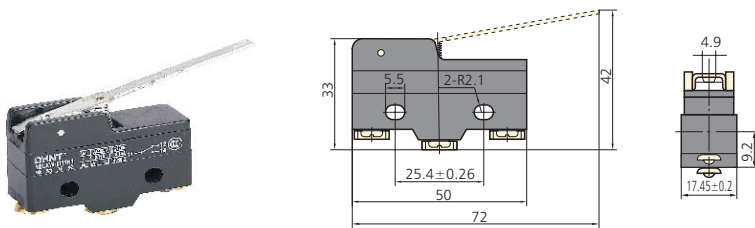

YBLXW-5/11G2, YBLXW-5/11G2/L

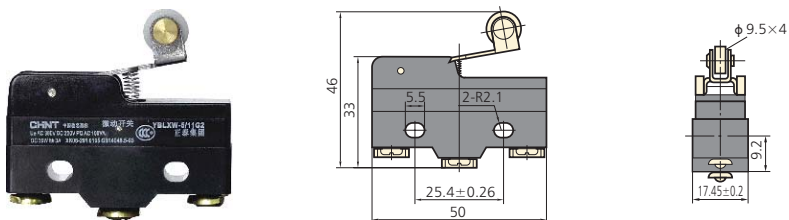

Microswitch

YBLXW-5/11G1、YBLXW-5/11G1/L

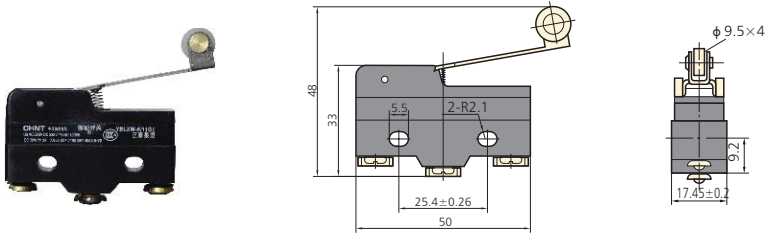

YBLXW-5/11G2277

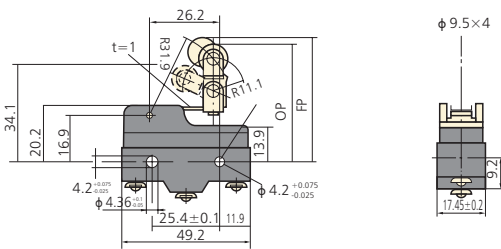

YBLXW-5/11GS

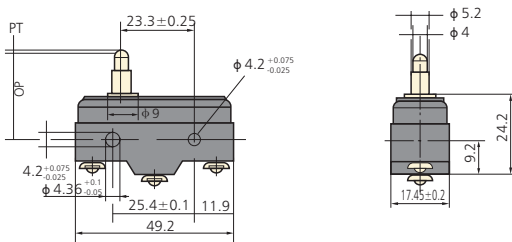

5. Ordering information

Explain the whole type, name and quantities of switches when ordering goods
 Such as: YBLXW-5/11 Z microswitch 100 pieces