



RADE KONČAR KONTAKTORI I RELEI D.O.O.

MOTORSKO ZAŠTITNA SKLOPKA TIP DMS 25
MOTOR PROTECTION SWITCHES TYPE DMS 25



MOTORSKE ZAŠTITNE SKLOPKE

Osnovne tehničke karakteristike

Podesiva prekostrujna prorada u 13 opsega od 0.1A do 25 A
 Zaštita od kratkog spoja podešena na 12xIe
 Nazivna kratkospojna prekidna moć, Icu = 6 kA / 400V
 Kompenzacija ambientne temperature
 Zaštita od ispada faze
 Izolacija i prekidanje u saglasnosti sa IEC 204-1
 Jednostavna i brza montaža na DIN-Letvu 35 mm prema EN 50022
 Široka lepeza dodataka za sve vrste rada

Tehničke informacije

Mehanička trajnost : 100 000 operacije
 Električna trajnost : 100 000 operacije
 Radna temperatura : min./max. °C -5/+40
 Učestanost : 30 operacije/čas
 Nominalni napon Ue : 400 V AC
 Izolacioni napon Ui : 690 V AC
 Nominalna radna struja Ie : 0.1-25 A acc. to setting range
 Nominalna termička struja Ith : 32 A
 Nominalni impulsni napon izdržljivosti Uimp : 6 kV
 Priključni vodovi : 0.75-2.5 / 0.75-6 mm²
 Standardi : IEC 60947-4-1; EN 60947-4-1

MOTOR PROTECTION SWITCHES

General Specifications

Adjustable overload release 13 ranges from 0.1 to 25 A
 Short circuit releases factor set at 12xIe
 Short circuit switching capacity minimum 3 kA / 400V
 Temperature compensated
 Phase failure protection
 Isolating and main switch function IEC 204-1
 Fast and simple mounting feature to 35 mm mounting rail
 Product variety with wide accessories fulfilling of all applications

Technical Information

Mechanical Life : 100 000 operations min.
 Electrical Life : 100 000 operation min.
 Operating Temperature : min./max. °C -5/+40
 Operating Frequency : 30 operations/hours
 Rated Operating Voltage Ue : 400 V AC
 Rated Insulation Voltage Ui : 690 V AC
 Rated Operating Current Ie : 0.1-25 A acc. to setting range
 Rated Continuous Current Ith : 32 A
 Rated Impulse Witstand Voltage Uimp : 6 kV
 Connection Cable Cross-Section : 0.75-2.5 / 0.75-6 mm²
 Standard : IEC 60947-4-1; EN 60947-4-1

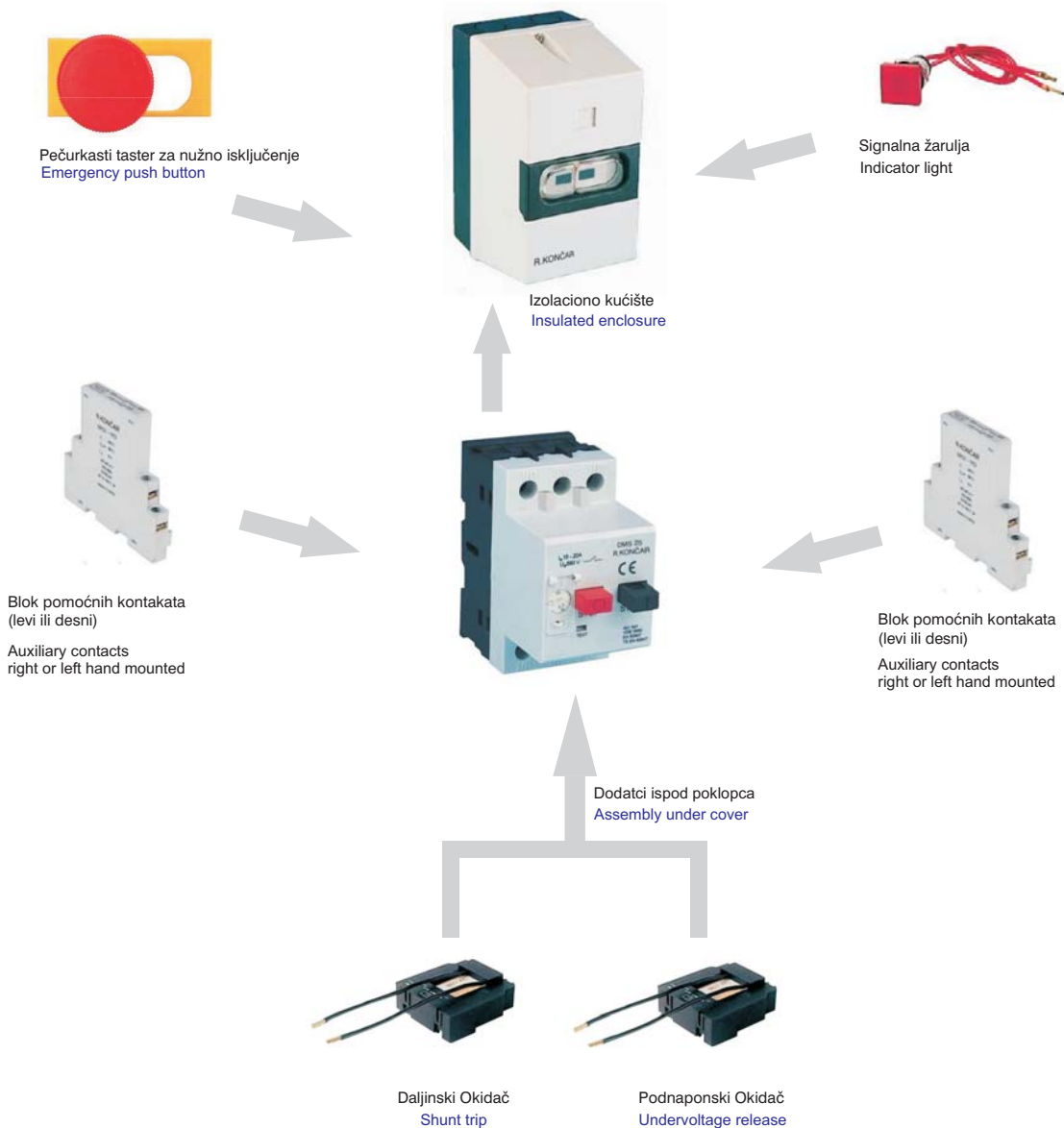





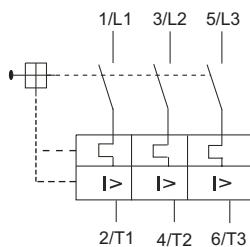



MOTORNO ZAŠTITNA SKLOPKA TIP DMS 25

MOTOR PROTECTION CIRCUIT BREAKER TYPE DMS 25



Tipaska oznaka Order Code	Maksimalna nominalna snaga 3-faznog motora [kW] AC 3 Maximum Rating [kW] AC 3					Opseg podešavanja struje Thermal Current Calibration Interval	Struja termičke prorade (A) Overload Release Setting Range	Struja djelovanja kratkospojnog okidača Responent Current of Short-Circuit Release
	220V 230V 240V	380V 400V 415V	440V	500V	600V 690V			
DMS 25 - 0.16	-	0.02	-	-	0.06	0.1 - 0.16	0.16	1.92
DMS 25 - 0.25	-	0.06	0.06	0.06	0.12	0.16 - 0.25	0.25	3
DMS 25 - 0.4	0.06	0.09	0.12	0.12	0.18	0.25 - 0.4	0.4	4.8
DMS 25 - 0.63	0.09	0.12	0.18	0.25	0.25	0.4 - 0.63	0.63	7.6
DMS 25 - 1	0.12	0.25	0.25	0.37	0.55	0.63 - 1	1	12
DMS 25 - 1.6	0.25	0.55	0.55	0.75	1.1	1 - 1.6	1.6	19.2
DMS 25 - 2.5	0.37	0.75	1.1	1.1	1.5	1.6 - 2.5	2.5	30
DMS 25 - 4	0.75	1.5	1.5	2.2	3	2.5 - 4	4	48
DMS 25 - 6.3	1.1	2.2	3	3	4	4 - 6.3	6.3	75.6
DMS 25 - 10	2.2	4	5	5.5	7.5	6.3 - 10	10	120
DMS 25 - 16	4	7.5	9	9	12.5	10 - 16	16	192
DMS 25 - 20	5.5	9	11	12.5	15	16 - 20	20	240
DMS 25 - 25	7.5	12.5	12.5	15	22	20 - 25	25	300

Tipaska oznaka Order Code	Opseg podešavanja struje Rated Continuous Current (A)	Nominalna struja osigurača koji je potreban u slučaju da očekivana struja kratkog spoja je veća od Icu Osigurači(gl.aM)(a) Back up-Fuse (required if the prospective fault current is greater than the short-circuitbraking capacity) Fuses(gl.aM)(a)				Moć prekidanja struje kratkog spoja Icu (kA) Switching Capacity Icu (kA)			
		230V	400V	500V	690V	230V	400V	500V	690V
DMS 25 - 0.16	0.1 - 0.16	-	-	-	-	100	100	100	100
DMS 25 - 0.25	0.16 - 0.25	-	-	-	-	100	100	100	100
DMS 25 - 0.4	0.25 - 0.4	-	-	-	-	100	100	100	100
DMS 25 - 0.63	0.4 - 0.63	-	-	-	-	100	100	100	100
DMS 25 - 1	0.63 - 1	-	-	-	-	100	100	100	100
DMS 25 - 1.6	1 - 1.6	-	-	-	-	100	100	3	2.5
DMS 25 - 2.5	1.6 - 2.5	-	-	25	20	100	100	3	2.5
DMS 25 - 4	2.5 - 4	-	-	35	25	100	100	3	2.5
DMS 25 - 6.3	4 - 6.3	-	-	50	35	6	3	2.5	2
DMS 25 - 10	6.3 - 10	-	80	50	35	6	3	2.5	2
DMS 25 - 16	10 - 16	80	80	63	35	6	3	2.5	2
DMS 25 - 20	16 - 20	80	80	63	50	6	3	2.5	2
DMS 25 - 25	20 - 25	80	80	60	50	6	3	2.5	2

<p>Tipska oznaka Product Code</p>	<p>Pomoćni kontakti Auxiliary Contact</p>  <p>Jedan ili dva pomoćna kontakta za motorsko zaštitnu sklopku, pozicionirani na levoj ili desnoj strani.</p> <p>One or two auxiliary contact units per motor protective circuit breaker fitted on left and right side of the device</p> <p>1 NC - 1 NC 1 NC - 1 NO 1 NO - 1 NO</p>  <p>NO; Normalno otvoren NC; Normalno zatvoren NO; Normally Open NC; Normally Close</p> <p>$I_{th} = 6A$ $I_e(AC 15) = 3A/250$</p>	<p>Tipska oznaka Product Code</p>	 <p>DMS - G30</p> <p>Tipka za isključivanje u nuždi (Cilindrična glava) Cylindrical head button stay-put twist to release</p>
<p>DMS - BP 02 DMS - BP 11 DMS - BP 20</p>	<p>Daljinski okidač Shunt trip</p>  <p>Za AC napon / For AC voltage (220 - 230 V, 50 Hz) (380-415 V, 50 Hz)</p> <p>Povezivanje provodnika ispod poklopca motorske zaštitne sklopke Connecting conductor mountable underneath the cover</p> <p>Opseg radnog napona: 70%Ue Snaga: 2.7/1.8 VA/W Pick up: 70% Ue Power: 2.7/1.8 VA/W</p>	<p>DMS - G40</p>  <p>Tipka za isključivanje u nuždi (Pečurkasta glava) Mushroom button stay-put twist to release</p>	<p>Tipka za isključivanje u nuždi (Pečurkasta glava) Mushroom button stay-put twist to release</p>
<p>DMS - DO 230 DMS - DO 400</p>	<p>Podnaponski okidač Undervoltage release</p>  <p>Za AC napon / For AC voltage (220 - 230 V, 50 Hz) (380-415 V, 50 Hz)</p> <p>Povezivanje provodnika ispod poklopca motorske zaštitne sklopke Connecting conductor mountable underneath the cover</p> <p>Opseg radnog napona: (70% - 35%)Ue Otpuštanje (70% - 35%)Ue Snaga: 2.7/1.8 VA/W Pick up: 85% Ue Drop out: (70% - 35%)Ue Power: 2.7/1.8 VA/W</p>	<p>MKS1 - N</p>  <p>N-Terminal N-Terminal</p>	<p>N-Terminal N-Terminal</p>
<p>DMS - PO 230 DMS - PO 400</p>	<p>Podnaponski okidač Undervoltage release</p>  <p>Za AC napon / For AC voltage (220 - 230 V, 50 Hz) (380-415 V, 50 Hz)</p> <p>Povezivanje provodnika ispod poklopca motorske zaštitne sklopke Connecting conductor mountable underneath the cover</p> <p>Opseg radnog napona: (70% - 35%)Ue Otpuštanje (70% - 35%)Ue Snaga: 2.7/1.8 VA/W Pick up: 85% Ue Drop out: (70% - 35%)Ue Power: 2.7/1.8 VA/W</p>	<p>MKS1 - S</p>  <p>Signalna sijalica Indicator light</p>	<p>Signalna sijalica Indicator light</p>

Tehnički podatci

- Montaža: bilo koi položaj
 Dozvoljeni moment zatezanja:
 - Glavni kontaktii: 1.2 Nm
 - Pomoćni kontakti: 1 Nm
 Nominalna frekencija: 40...60 Hz
 Gubitci: 6 W
 Vreme prorade DMS 25 kod kratkog spoja
 - Minimalno vreme prorade ms: 2
 - Kašnenje pri otvaranju ms: 2
 - Vreme otvaranja ms: 7

Technical specifications

- Mounting position: normally any.
 Tightening torque for terminal screws:
 - Main terminals: 1.2 Nm
 - Auxiliary terminals: 1 Nm
 Rated frequency: 40...60 Hz
 Heating losses due to the current: 6 W
 Switching Times at Short Circuit DMS 25
 - Minimum Delay Time ms: 2
 - Opening Delay ms: 2
 - Opening Time ms: 7

Kategorija Upotrebe AC 3 max. 690 V / Utilization Category AC 3 max. 690 V

Područje podešavanja [A] Current Setting [A]	Osigurači [A] Fuse [A]	Područje podešavanja [A] Curren Setting [A]	Osigurači [A] Fuse [A]	Područje podešavanja [A] Curren Setting [A]	Osigurači [A] Fuse [A]
0.4 - 0.63	2	2.5 - 4	10	16 - 20	50
0.63 - 1	4	4 - 6.3	16	20 - 25	50
1 - 1.6	6	6.3 - 10	25		
1.6 - 2.5	6	10 - 16	35		

Karakteristika prorade

Karakteristika prorade prikazuje vreme prorade u zavisnosti od struje. Na dijagramu su prikazani glavne vrednosti vremena prorade motorsko zaštitne sklopke u hladnom stanju kod ambientne temperature od 20°C. Vreme prorade u toplom stanju motorsko zaštitne sklopke se reducira približno za 25% od prikazanog vremena prorade na dijagramu.

Na zahtev kupca možemo prezentirati vreme prorade za svako područje DMS 25

Tripping Characteristics

The tripping characteristics show the tripping time in relation to the response current. They show main values of the tolerance range at an ambient temperature of 20 °C, starting from cold. The tripping of overload releases at operational temperature is reduced to approximately 1/4 of the shown. Specific characteristics for each individual setting range are available on request.

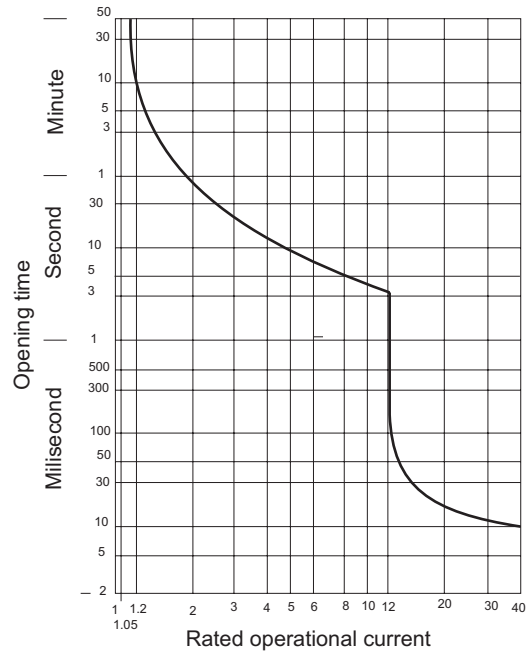

Kućište od izolacionog materijala

Stepen zaštite IP 55

Insulated enclosure

Protection degree IP 55

PNDMS 25



Tipska oznaka Order Code	Opseg podešavanja struje Rated Continuous Current
PNDMS 25 - 0.16	0.1 - 0.16
PNDMS 25 - 0.25	0.16 - 0.25
PNDMS 25 - 0.4	0.25 - 0.4
PNDMS 25 - 0.63	0.4 - 0.63
PNDMS 25 - 1	0.63 - 1
PNDMS 25 - 1.6	1 - 1.6
PNDMS 25 - 2.5	1.6 - 2.5
PNDMS 25 - 4	2.5 - 4
PNDMS 25 - 6.3	4 - 6.3
PNDMS 25 - 10	6.3 - 10
PNDMS 25 - 16	10 - 16
PNDMS 25 - 20	16 - 20
PNDMS 25 - 25	20 - 25

DIMENZIJE (mm)
DIMENSIONS (mm)

DMS 25

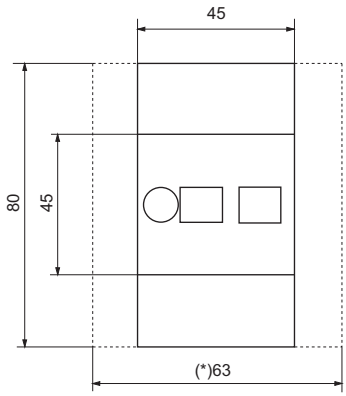

(*)Sa pomoćnim kontaktima
 With auxiliary contact BP

DIN rail EN 50022-35

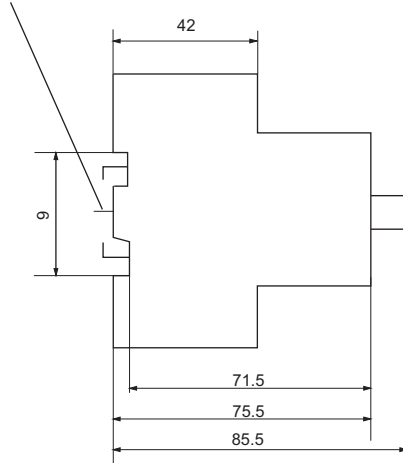

DMS-BP

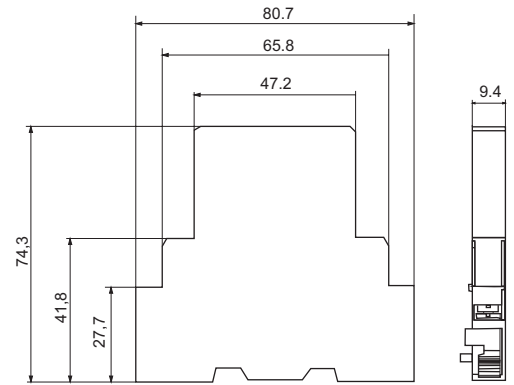

PNDMS 25

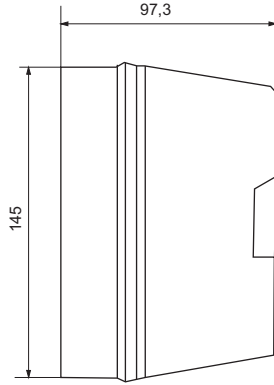
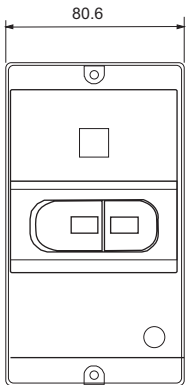

PNDMS 25 - G30

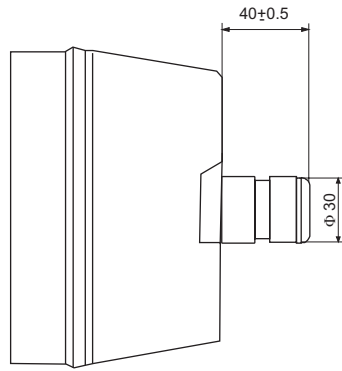

PNDMS 25 - G40

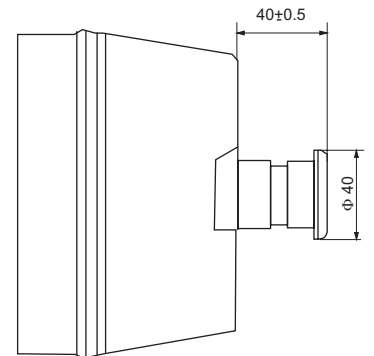

DMS - G30

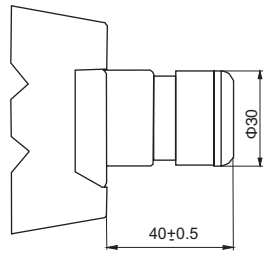

DMS - G40

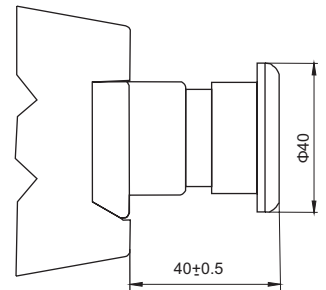

RADE KONČAR
KONTAKTORI I RELEI D.O.O.

1000 - Skopje, Macedonia
 III Makedonska brigada b.b.
 Tel./Fax ++389 (0)2/ 2461 106; 2463 620;
 2465 586; 2463 596

E-mail: marketing@radekoncar.com.mk
 E-mail: export@radekoncar.com.mk
 E-mail: prodaja@radekoncar.com.mk
<http://www.radekoncar.com.mk>

