



## NS2 Manual Motor Starter

### 1. General

- 1.1 Certificates: SEMKO, CE, UkrSEPRO, EAC, RCC, UL;
- 1.2 Electric ratings: AC690V, 25A, 80A;
- 1.3 Standard: IEC/EN 60947-2, IEC60947-4-1



### 2. Type designation

NS2 - □ □ /□

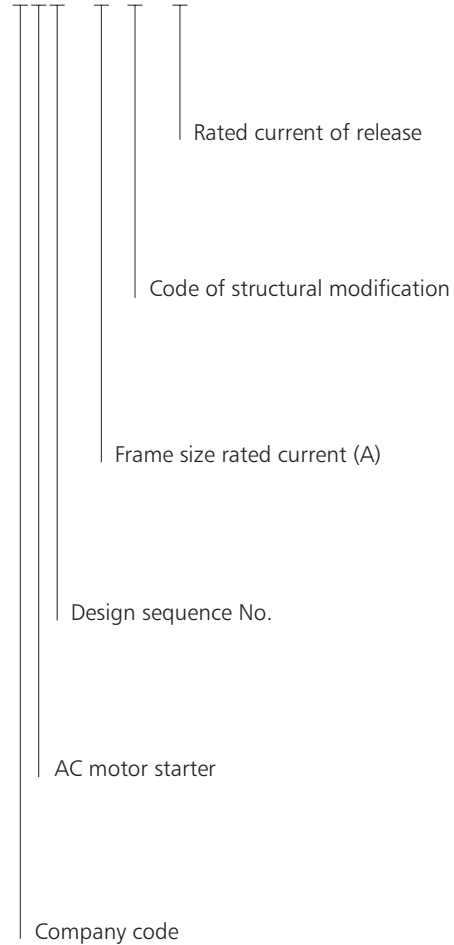

### 3. Operating conditions

- 3.1 Temperature:  $-5^{\circ}\text{C} \sim +40^{\circ}\text{C}$ , average temperature in 24 hours not exceed  $+35^{\circ}\text{C}$
- 3.2 Altitude: not exceed 2000m
- 3.3 Air conditions:
  - At mounting site, relative humidity not exceed 50% at the max temperature of  $+40^{\circ}\text{C}$ , higher relative humidity is allowable under lower temperature, for example, RH could be 90% at  $+20^{\circ}\text{C}$
- 3.4 Pollution grade: Grade III
- 3.5 Trip class:
  - 10A(NS2-25, NS2-25X, NS2-32, NS2-32X)
  - 10 (NS2-80, NS2-80B)
- 3.6 Rated operational system: Continuous operational system
- 3.7 Mounting conditions:
  - The inclination between the mounting plane and the vertical plane shall not exceed  $5^{\circ}$
  - The product shall be installed and operated at a place without obvious shake, impact and vibration.

#### 4. Technical data

##### 4.1 Protection properties

##### Over-load Protection Properties

Series No.	Multiple of setting current	Initial status	Time		Expected results	Ambient temperature
1	1.05	Cold status	$t \geq 2h$		Non-tripping	$+20^{\circ}\text{C} \pm 2^{\circ}\text{C}$
2	1.20	Heat status (right after test.1)	$t < 2h$		Tripping	$+20^{\circ}\text{C} \pm 2^{\circ}\text{C}$
3	1.50	Heat status (right after test.1)	Tripping class	10A $t < 2\text{min}$	Tripping	$+20^{\circ}\text{C} \pm 2^{\circ}\text{C}$
		10 $t < 4\text{min}$				
4	7.20	Cold status	Tripping class	10A $2s < t \leq 10s$	Tripping	$+20^{\circ}\text{C} \pm 2^{\circ}\text{C}$
		10 $4s < t \leq 10s$				

##### Phase failure protection properties

Series No.	Multiple of setting current		Initial status	Time	Expected results	Ambient temperature
	Any 2 phase	The other phase				
1	1.0	0.9	Cold status	$t \geq 2h$	Non-tripping	$+20^{\circ}\text{C} \pm 2^{\circ}\text{C}$
2	1.15	0	Heat status (right after test.1)	$t < 2h$	Tripping	$+20^{\circ}\text{C} \pm 2^{\circ}\text{C}$

##### Temperature compensation properties

Series No.	Multiple of setting current	Initial status	Time	Expected results	Ambient temperature
1	1.0	Cold status	$t \geq 2h$	Non-tripping	$+40^{\circ}\text{C} \pm 2^{\circ}\text{C}$
2	1.2	Heat status (right after test.1)	$t < 2h$	Tripping	$+40^{\circ}\text{C} \pm 2^{\circ}\text{C}$
3	1.5	Heat status (through 1.0 times rated current ,after thermal equilibrium is reached)	$t < 2\text{min}$	Tripping	$+40^{\circ}\text{C} \pm 2^{\circ}\text{C}$
4	1.05	Cold status	$t \geq 2h$	Non-tripping	$-5^{\circ}\text{C} \pm 2^{\circ}\text{C}$
5	1.3	Heat status (right after test.3)	$t < 2h$	Tripping	$-5^{\circ}\text{C} \pm 2^{\circ}\text{C}$
6	1.5	Heat status (through 1.0 times rated current ,after thermal equilibrium is reached)	$t < 4\text{min}$	Tripping	$-5^{\circ}\text{C} \pm 2^{\circ}\text{C}$

4.2 Technical parameters

Model			NS2-25, NS2-25X			
Picture						
Rated insulation voltage $U_i$ (V)			690			
Rated operational voltage $U_e$ (V)			230/240, 400/415, 440, 500, 690			
Rated impulse withstand voltage $U_{imp}$ (V)			8000			
Regulating rang of setting current (A)			0.1~0.16	0.16~0.25	0.25~0.4	0.4~0.63
Rated current of release			0.16	0.25	0.4	0.63
Rated ultimate short-circuit breaking capacity $I_{cu}$ (kA)	230/240V		100	100	100	100
	400/415V		100	100	100	100
	440V		100	100	100	100
	480/500V		100	100	100	100
	660/690V		100	100	100	100
Rated service short-circuit breaking capacity $I_{cs}$ (kA)	230/240V		100	100	100	100
	400/415V		100	100	100	100
	440V		100	100	100	100
	480/500V		100	100	100	100
	660/690V		100	100	100	100
Arcing distance (mm)			40	40	40	40
Standard rated power of three-phase motor (kW)	230/240V		-	-	-	-
	400V		-	-	-	-
	415V		-	-	-	-
	440V		-	-	-	-
	500V		-	-	-	-
	660/690V		-	-	-	0.37
Current setting value of instantaneous electromagnetic release $I_r$ (A)			1.5	2.4	5	8
Current rating of fuse-link of back-up fuse, which is only needed in case of $I_{cc} > I_{cu}$ ( $I_{cc}$ : prospective short-circuit breaking current)	230/240V	aM A	★	★	★	★
		gI/gG A	★	★	★	★
	400/415V	aM A	★	★	★	★
		gI/gG A	★	★	★	★
	440V	aM A	★	★	★	★
		gI/gG A	★	★	★	★
	500V	aM A	★	★	★	★
		gI/gG A	★	★	★	★
★: fuse is not required	690V	aM A	★	★	★	★
		gI/gG A	★	★	★	★
Degree of protection			IP2L0	IP2L0	IP2L0	IP2L0

NS2-25, NS2-25X



690

230/240, 400/415, 440, 500, 690

8000

0.63~1	1~1.6	1.6~2.5	2.5~4	4~6.3	6~10
1	1.6	2.5	4	6.3	10
100	100	100	100	100	100
100	100	100	100	100	100
100	100	100	100	50	15
100	100	100	100	50	10
100	100	3	3	3	3
100	100	100	100	100	100
100	100	100	100	100	100
100	100	100	100	50	15
100	100	100	100	50	10
100	100	2.25	2.25	2.25	2.25
40	40	40	40	40	40
-	-	0.37	0.75	1.1	2.2
-	0.37	0.75	1.5	2.2	4
-	-	0.75	1.5	2.2	4
0.37	0.55	1.1	1.5	3	4
0.37	0.75	1.1	2.2	3.7	5.5
0.55	1.1	1.5	3	4	7.5
13	22.5	33.5	51	78	138
★	★	★	★	★	★
★	★	★	★	★	★
★	★	★	★	★	★
★	★	★	★	★	★
★	★	★	★	50	50
★	★	★	★	63	63
★	★	★	★	50	50
★	★	★	★	63	63
★	★	16	25	32	32
★	★	20	32	40	40
IP2L0	IP2L0	IP2L0	IP2L0	IP2L0	IP2L0

4.3 Technical parameters

Model			NS2-25, NS2-25X, NS2-32, NS2-32X				
Picture							
Rated insulation voltage $U_i$ (V)			690				
Rated operational voltage $U_e$ (V)			230/240, 400/415, 440, 500, 690				
Rated impulse withstand voltage $U_{imp}$ (V)			8000				
Regulating rang of setting current (A)			9~14	13~18	17~23	20~25	24~32
Rated current of release			14	18	23	25	32
Rated ultimate short-circuit breaking capacity $I_{cu}$ (kA)	230/240V		100	100	50	50	50
	400/415V		15	15	15	15	10
	440V		8	8	6	6	6
	480/500V		6	6	4	4	4
	660/690V		3	3	3	3	3
Rated service short-circuit breaking capacity $I_{cs}$ (kA)	230/240V		100	100	50	50	50
	400/415V		7.5	7.5	6	6	5
	440V		4	4	3	3	3
	500V		4.5	4.5	3	3	3
	660/690V		2.25	2.25	2.25	2.25	2.25
Arcing distance (mm)			40	40	40	40	40
Standard rated power of three-phase motor (kW)	230/240V		3	4	5.5	5.5	7.5
	400V		5.5	7.5	11	11	15
	415V		5.5	9	11	11	15
	440V		7.5	9	11	11	15
	500V		7.5	9	11	15	18.5
	660/690V		9	11	15	18.5	25
Current setting value of instantaneous electromagnetic release $I_r$ (A)			170	223	327	327	416
Current rating of fuse-link of back-up fuse, which is only needed in case of $I_{cc} > I_{cu}$ ( $I_{cc}$ : prospective short-circuit breaking current)	230/240V	aM A	★	★	80	80	80
		gI/gG A	★	★	100	100	100
	400/415V	aM A	63	63	80	80	80
		gI/gG A	80	80	100	100	100
	440V	aM A	50	50	63	63	63
		gI/gG A	63	63	80	80	80
	500V	aM A	50	50	50	50	50
		gI/gG A	63	63	63	63	63
★: fuse is not required	690V	aM A	40	40	40	40	40
		gI/gG A	50	50	50	50	50
Degree of Protection			IP2L0	IP2L0	IP2L0	IP2L0	IP2L0

NS2-80B



690

230/240, 400/415

8000

	16~25	25~40	40~63	56~80
	25	40	63	80
	-	-	-	-
	15	15	15	15
	-	-	-	-
	-	-	-	-
	-	-	-	-
	7.5	7.5	7.5	7.5
	-	-	-	-
	-	-	-	-
	-	-	-	-
	50	50	50	50
	5.5	11	15	22
	11	18.5	30	40
	11	22	33	45
	-	-	-	-
	-	-	-	-
	-	-	-	-
	327	480	756	960
	★	★	★	★
	★	★	★	★
	250	250	315	315
	315	315	400	400
	-	-	-	-
	-	-	-	-
	-	-	-	-
	-	-	-	-
	-	-	-	-
	-	-	-	-
	IP2L0	IP2L0	IP2L0	IP2L0

4.3 Technical parameters

Model		NS2-80				
Picture						
Rated insulation voltage $U_i$ (V)		690				
Rated operational voltage $U_e$ (V)		400/415 660/690V				
Rated impulse withstand voltage $U_{imp}$ (V)		8000				
Regulating rang of setting current (A)		16~25	25~40	40~63	56~80	
Rated current of release		25	40	63	80	
Rated ultimate short-circuit breaking capacity $I_{cu}$ (kA)	230/240V	-	-	-	-	
	400/415V	35	35	35	35	
	440V	-	-	-	-	
	480/500V	-	-	-	-	
	660/690V	4	4	4	4	
Rated service short-circuit breaking capacity $I_{cs}$ (kA)	230/240V	-	-	-	-	
	400/415V	17.5	17.5	17.5	17.5	
	440V	-	-	-	-	
	500V	-	-	-	-	
	660/690V	2	2	2	2	
Arcing distance (mm)		50	50	50	50	
Standard rated power of three-phase motor (kW)	230/240V	5.5	11	15	22	
	400V	11	18.5	30	-	
	415V	11	22	33	45	
	440V	11	22	33	45	
	500V	15	25	40	55	
	660/690V	18.5	33	55	63	
Current setting value of instantaneous electromagnetic release $I_r$ (A)		327	480	756	960	
Current rating of fuse-link of back-up fuse, which is only needed in case of $I_{cc} > I_{cu}$ ( $I_{cc}$ : prospective short-circuit breaking current)	230/240V	aM A	-	-	-	-
		g/gG A	-	-	-	-
	400/415V	aM A	250	250	315	315
		g/gG A	315	315	400	400
	440V	aM A	-	-	-	-
		g/gG A	-	-	-	-
	500V	aM A	-	-	-	-
		g/gG A	-	-	-	-
★: fuse is not required	690V	aM A	160	160	200	200
		g/gG A	200	200	250	250
Degree of Protection		IP2L0	IP2L0	IP2L0	IP2L0	

## 5. Other

### 5.1 Starters accessories

#### 5.1.1 Type, model and specifications of accessories (see Table 10).

Table 10

Description of accessories	Accessories Model				Accessories Specifications
	NS2-25, NS2-32 applies	NS2-25X, NS2-32X applies	NS2-80 applies	NS2-80B applies	
Undervoltage release	NS2-UV110	NS2-UV110	NS2-UV110	-	110~115V, 50Hz; 127V,60Hz
	NS2-UV220	NS2-UV220	NS2-UV220	-	220~240V, 50Hz
	NS2-UV380	NS2-UV380	NS2-UV380	-	380~400V, 50Hz; 440V,60Hz
Shunt release	NS2-SH110	NS2-SH110	NS2-SH110	-	110~115V, 50Hz; 127V,60Hz
	NS2-SH220	NS2-SH220	NS2-SH220	-	220~240V, 50Hz
	NS2-SH380	NS2-SH380	NS2-SH380	-	380~400V, 50Hz; 440V,60Hz
Instantaneous auxiliary contact (front hanging)	NS2-AE20	NS2-AE20	NS2-AE20	-	2NO
	NS2-AE11	NS2-AE11	NS2-AE11	-	1NO+1NC
Instantaneous auxiliary contact (side hanging)	NS2-AU20	NS2-AU20	NS2-AU20	NS2-AU20	2NO
	NS2-AU11	NS2-AU11	NS2-AU11	NS2-AU11	1NO+1NC
Fault signal contact and instantaneous auxiliary contact	NS2-FA0110	NS2-FA0110	-	-	1NC+1NO
	NS2-FA0101	NS2-FA0101	-	-	1NC+1NC
	NS2-FA1010	NS2-FA1010	-	-	1NO+1NO
	NS2-FA1001	NS2-FA1001	-	-	1NO+1NC
Waterproof mounting box	NS2-MC	-	-	-	-
Mounting box with emergency stop button	NS2-MC01	-	-	-	-

#### 5.1.2 Undervoltage trip device

NS2-UV110, UV220, UV380'S, performance:

- Rated insulation voltage  $U_i$  (V): 690.
- Operating characteristics: When the voltage drops to 70% and 35% of the rated voltage range, undervoltage trip device shall act;

Undervoltage trip device in the power supply voltage is less than 35% of the rated voltage of the trip device, the undervoltage trip device should be able to prevent the starter from closing; when the power supply voltage is equal to or greater than 85% of the rated voltage of the trip device, the undervoltage trip device should guarantee closure of the starter.

#### 5.1.3 The characteristics of the shunt trip

NS2-SH110, SH220, SH380:

- Rated insulation voltage  $U_i$  (V): 690.
- Operating characteristics: the operating voltage range of the shunt trip device is rated working voltage of 70% ~ 110%.

#### 5.1.4 Characteristics of the instantaneous auxiliary contact NS2-AE20, AE11 (front hanging)

- rated insulation voltage  $U_i$  (V): 250;
- agreed thermal current  $I_{th}$  (A): 2.5;
- type, rated voltage and rated operating current (see Table 11) of instantaneous auxiliary contacts.



NS2-UV

NS2-SH

NS2-AE

Table 11

Utilization category	AC-15				DC-13		
	24	48	110/127	230/240	24	48	60
Rated operating voltage $U_e$ (V)	24	48	110/127	230/240	24	48	60
Rated operating current $I_e$ (A)	2	1.25	1	0.5	1	0.3	0.15
Normal operating power $P$ (W)	48	60	127	120	24	15	9



5.1.5 Instantaneous auxiliary contact NS2-AU20, AU11 performance (side hung):  
 a. rated insulation voltage  $U_i$  (V): 690;  
 b. agreed thermal current  $I_{th}$  (A): 6;  
 c. type, rated voltage and rated operating current of the instantaneous auxiliary contacts(see Table 12).

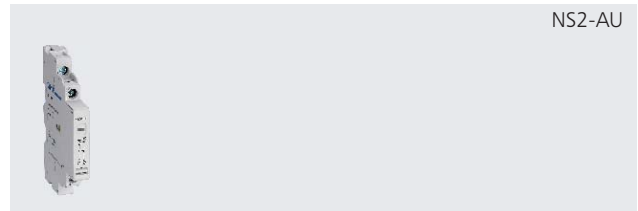

NS2-AU

Table 12

Utilization category	AC-15							DC-13				
	Rated operating voltage $U_e$ (V)	48	110/127	230/240	380/415	440	500	690	24	48	60	110
Rated operating current $I_e$ (A)	6	4.5	3.3	2.2	1.5	1	0.6	6	5	3	1.3	0.5
Normal operating power $P$ (W)	300	500	720	850	650	500	400	140	240	180	140	120

5.1.6 Characteristics of the fault signal contact and instantaneous auxiliary contact NS2-FA:  
 Fault signal contact and instantaneous auxiliary contact NS2-FA, consist of the fault signal contact and instantaneous auxiliary contact. They have different use types and characteristics.  
 a. rated insulation voltage  $U_i$  (V): 690;  
 b. agreed thermal currents of instantaneous auxiliary contacts: 6, agreed thermal current of fault signal contacts  $I_{th}$  (A): 2.5;  
 c. the use type, rated voltage and rated work current (see Table 12) of the instantaneous auxiliary contact same as the NS2-AU instantaneous auxiliary contact; the use type, rated voltage and rated operating current (see Table 13) of the fault signal contacts.

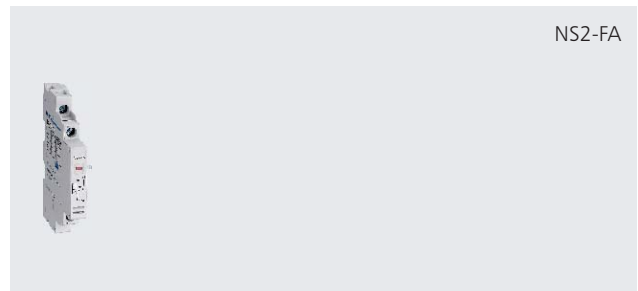

NS2-FA

Table 13

Utilization category	AC-14				DC-13		
	Rated operating voltage $U_e$ (V)	24	48	110/127	230/240	24	48
Rated operating current $I_e$ (A)	1.5	1	0.5	0.3	1	0.3	0.15
Normal operating power $P$ (W)	36	48	72	72	24	15	9
Operating performance (time)	1000	1000	1000	1000	1000	1000	1000

5.1.7 Non-normal making and breaking capacity (see Table 14) of fault signal contact and instantaneous auxiliary contact.

Table 14

Use type	Connection		Disconnection				On-off operation cycles and operating frequency		
	$I/I_e$	$U/U_e$	$\cos \Phi$ or $T_{0.95}$	$I/I_e$	$U/U_e$	$\cos \Phi$ or $T_{0.95}$	Operating cycles	Operating cycles per minutes	Energize Time
AC-14	6	1.1	0.7	6	1.1	0.7	10	2	0.05
AC-15	10	1.1	0.3	10	1.1	0.3	10	2	0.05
DC-13	1.1	1.1	6Pe	1.1	1.1	6Pe	10	2	0.05

Note:  $Pe \geq 50W$ ,  $T_{0.95}$  upper limit  $\approx 6Pe \leq 300ms$ .

6. Overall and mounting dimension (mm)

NS2-25X, NS2-32X

NS2-25, NS2-32

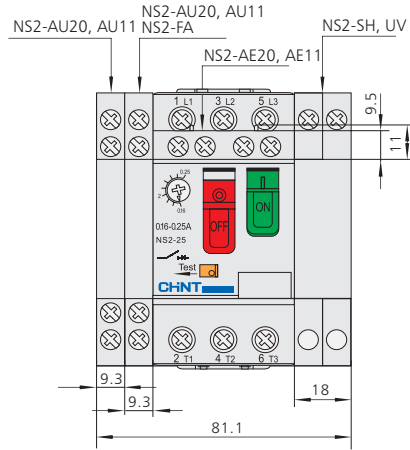
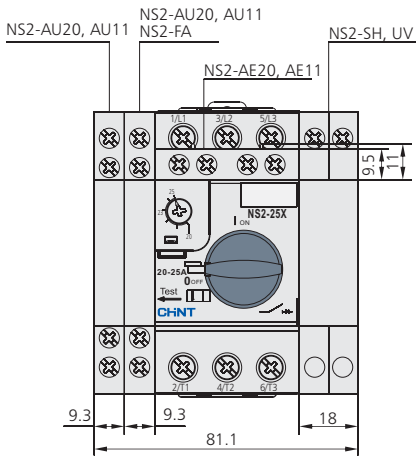

NS2-80

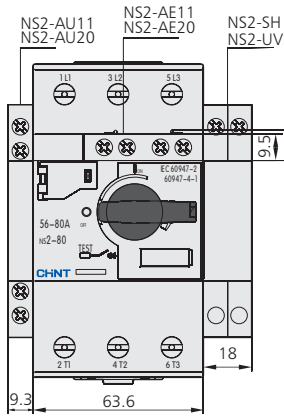

NS2-25X, NS2-32X

NS2-80

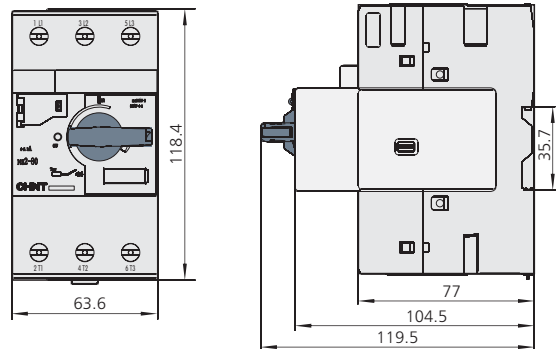
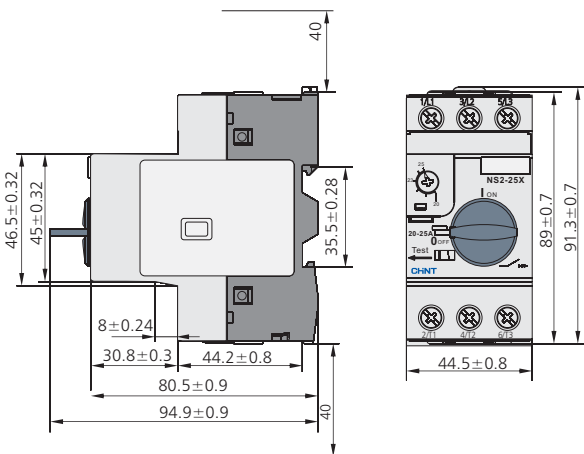

NS2-25, NS2-32

NS2-80B

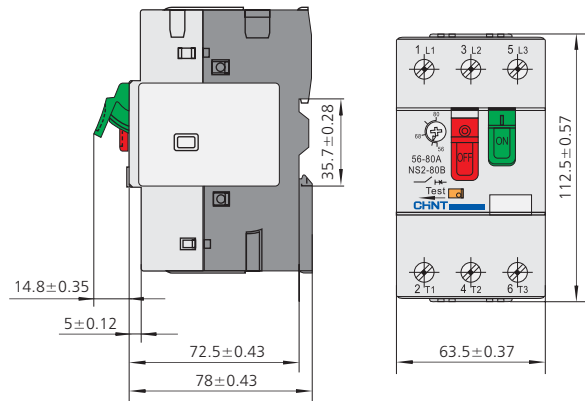
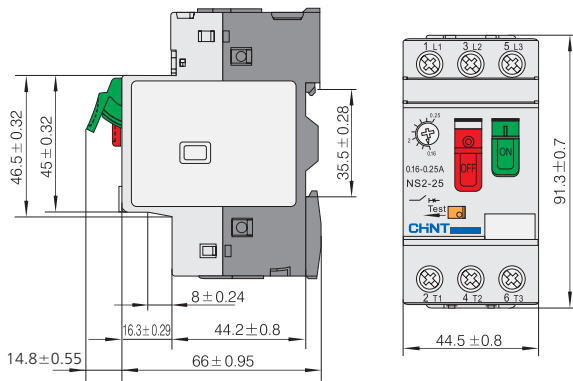

NS2-MC

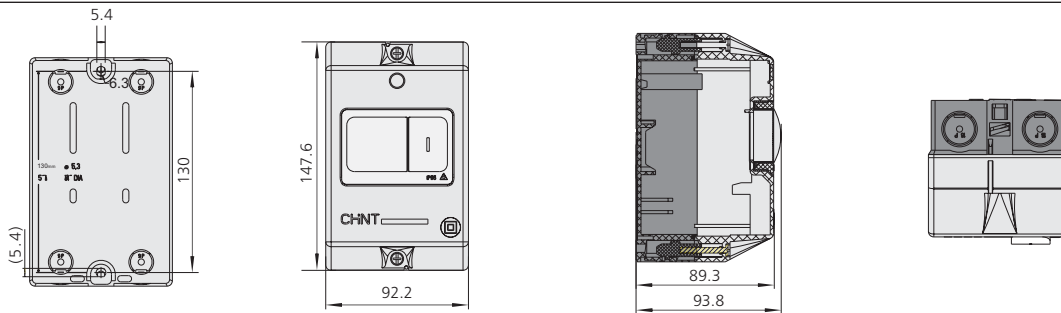

NS2-MC01

